

BAG INSERTER ZIM-11

From a roll of polyethylene film, the compact ZIM-11 automatically inserts bags into boxes, crates or trays.

The bag inserter runs with **made-to-measure bags** or **pre-made bags from a reel** and is available in mono and multi box footprint.

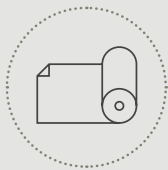
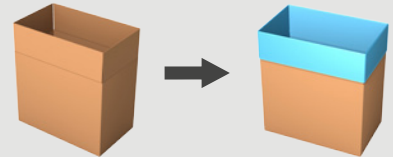

made-to-measure
bags from a reel

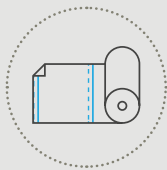

pre-made bags
from a reel

SOF
seal off first



Case lining convenience

- Continuous production thanks to the **automatic film roll exchange**.
- Super **compact**: only 47 x 40 inches floor space needed.

Your intelligent bag inserter

- Up to **8 cases/minute**.
- Integrated automatic **bag detection**.
- **Elimination of operator errors** thanks to fully automatic format change.
- Quick and **ergonomic film roll loading**.



Watch our videos
at pattyn.com

TECHNICAL SPECIFICATIONS ZIM-11

Made-to-measure bags from a reel

- Continuous tubular gusseted film on a reel.
- Impulse sealing for a controlled and clean seal.

Pre-made bags from a reel

- Pre-sealed and perforated bags on a reel for optimal convenience.

Failsafe bag opening

- Mechanical grippers instead of delicate vacuum cups.

Perfectly controlled bag insertion

- Case flap holders for perfect case flap positioning.
- Spoons with integrated bag detection system.
- Smart box lift for vertical box positioning.

Use of stepper motor technology

- Self-resolving.

Standard equipped with:

- Colour touch panel for easy operation.
- Infeed conveyor with integrated box centering device and separator.

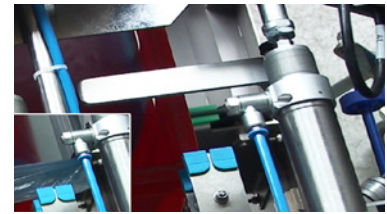

Mechanical grippers & spoons with bag detection



Case flap holders



Integrated bag detection

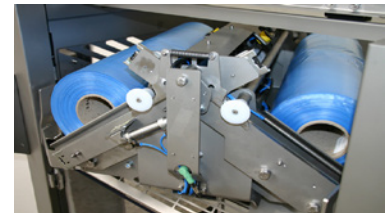

Automatic film roll exchange (optional)

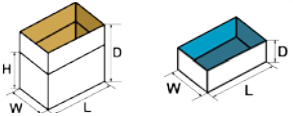

Super compact

CONTAINER SPECIFICATIONS (For other dimensions, please contact Pattyn)	
Type	Boxes, trays and crates
Range (L x W // D) inches	Mono or multi footprint (L x W) /variable heights Min. 12" (L) x 8" (W) // 8" (D) Max. 24" (L) x 16" (W) // 24" (D)
	Outside dimensions
FILM SPECIFICATIONS	
Type	Tubular film with gussets
Thickness	As from 0,6 mil
Weight of film roll	Max. 26 lbs
Outside diameter film roll	Max. 9"
Inside diameter of core	3"
OUTPUT AND CONSUMPTION	
Output ZIM with made-to-measure bags	Up to 8 c/min
Output ZIM with pre-made bags	Up to 6 c/min
Installed power	4,5 kW
Voltage	3 x 480 V + E / 60 Hz
Air supply	90 PSI, (1/2" min)
Air consumption	2 ft ³ / cycle
Weight	1102 lbs
OPTIONS (More options are available, please contact Pattyn)	
Automatic film roll exchange	Advanced stainless steel execution
Multi colour warning light	Air plunger for improved bag positioning
Modifications to the box lift to run crates with open bottom	Access point for remote support

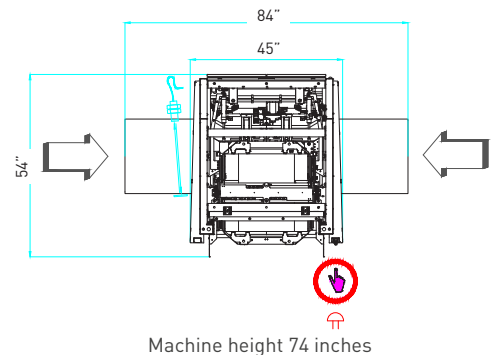

Pattyn North America Inc.
N76 W30500 County Road Vv
Hartland, WI. 53029 - U.S.A

Ph +1 262-966-0300
Fax +1 262-966-0312
SalesUsa@pattyn.com



The description, pictures and information given have an indicative value. We reserve the right to make changes without notice. Information and content is property of Pattyn. For customized executions please contact Pattyn. ZIM-11 2018 - V01

PATTYN[®]

Turnkey solutions for industrial packaging.