

BAGMAKER INSERTER RAZIM-31-LC

From a roll of **gusseted** or **non gusseted** tubular film, the Razim-31-LC automatically makes, cuts and inserts bags into crates, clamshell boxes and low cartons.

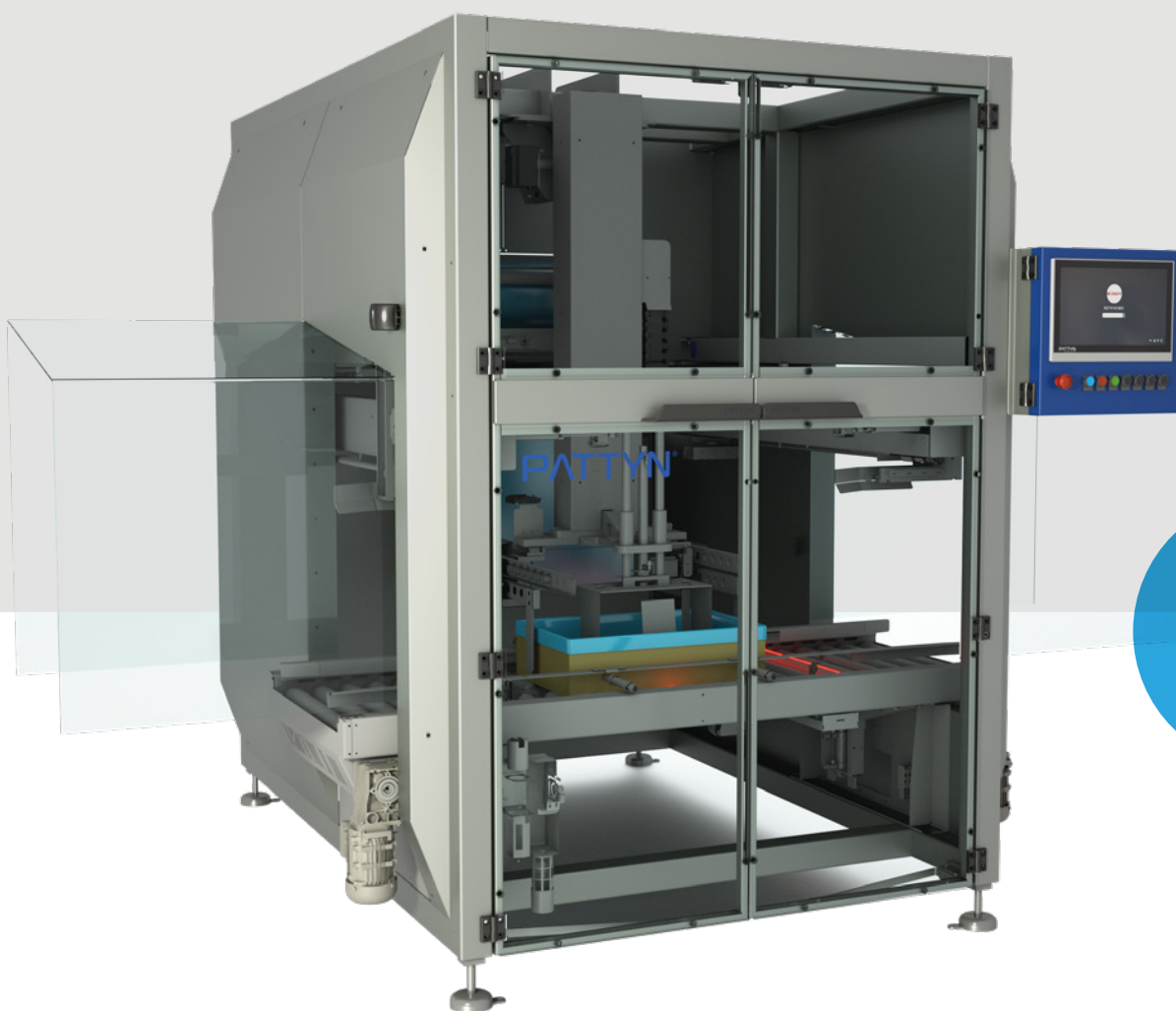
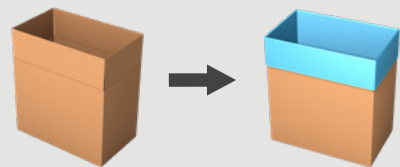

VERSATILE
BAG
INSERTION

For crates & clamshell boxes

- **Integrated mechanical plunger.**
- Perfect balance of speed and versatility

Hygienic design

- Up to **16** cases/minute.
- Designed for maximum cleaning accessibility.



Watch our videos
at pattyn.com

TECHNICAL SPECIFICATIONS

RAZIM-31-LC

Leakproof bag

- Impulse sealing for a controlled, clean and leakproof seal.

Failsafe bag opening

- Mechanical grippers instead of delicate vacuum cups.

Perfect balance of speed & versatility

- High speed to match your production rate
- Use of different types of gusseted and non gusseted tubular film
- Use of multi-layer high barrier film for different applications.
- Possibility to work with crates, clamshell boxes & low cartons

Standard equipped with:

- Integrated mechanical plunger.
- Maintenance free V-shaped guillotine knife for a perfect film cut.
- 15" HMI for easy operation.
- Remote Access Point (one per line).



Mechanical grippers

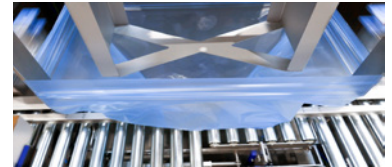

Stepper motor driven spoon module

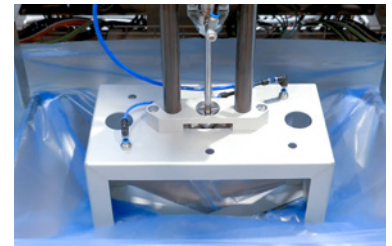

Integrated mechanical plunger

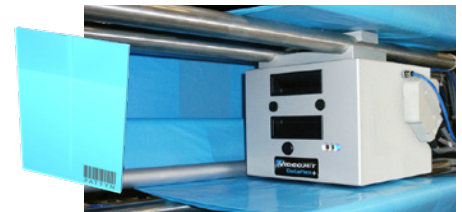

Optional thermo transfer printer

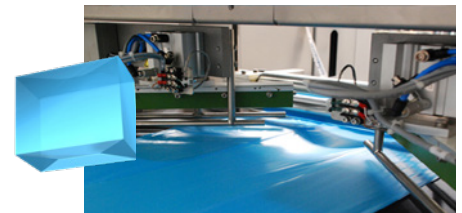

Optional corner seal unit 45°

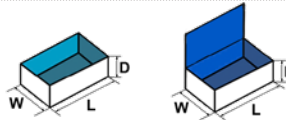
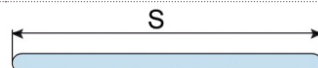
CONTAINER SPECIFICATIONS (For other dimensions, please contact Pattyn)	
Type	Cases
Range (L x W // D) mm	Mono or multi footprint (L x W) Min. 300 (L) x 200 (W) // 95 (D) Max. 600 (L) x 400 (W) // 250 (D)
	Outside dimensions
FILM SPECIFICATIONS	
Type	Gusseted or non gusseted tubular film* : aluminium coated film, multi-layer high barrier film
* When running non gusseted tubular film: Max. S = 840 mm (S = half of circumference of the film).	
Thickness	Min. 15 µm
Weight of film roll	Max. 60 kg
Outside diameter film roll	Max. 450 mm
Inside diameter of core	76 mm
OUTPUT AND CONSUMPTION	
Output single liner	Up to 16 c/min when using gusseted film Up to 8 c/min when using non gusseted film
Output double liner	Please contact Pattyn
Installed power	11,5 kW
Voltage	3 x 400 V + N + E / 50 Hz
Air supply	6 bar / 1/2" min
Air consumption	60 NI / cycle
Weight	1900 kg
OPTIONS (More options are available, please contact Pattyn)	
Advanced stainless steel execution	Two active seal bars
Mechanical bag-in-box detection	Cross seal unit (only for gusseted film)
Film roll trolley	12 kg film roll (only for gusseted film)
Thermo transfer printer for real time printing on bags (traceability)	
Multiple case heights (For limited range only, to be checked by Pattyn)	

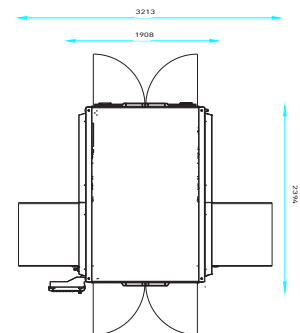

Machine height 3143 mm

Machine height as reference only,
depending on case height.

Pattyn Belgium nv
Industriepark 'Blauwe Toren'
Hoge Hul 2, 8000 Brugge - Belgium

T +32 (0) 50 450 480
info@pattyn.com
www.pattyn.com



The description, pictures and information given have an indicative value. We reserve the right to make changes without notice. Information and content is property of Pattyn. For customised executions please contact Pattyn. Razim-31-LC 2023 - V01

PATTYN[®]

Turnkey solutions for industrial packaging.