

BAG INSERTER ZIM-31

From a roll of polyethylene film, the compact ZIM-31 automatically inserts bags into boxes, crates or trays.

The bag inserter runs with **made-to-measure bags or pre-made bags from a 12 kg reel** and handles multi box footprints.

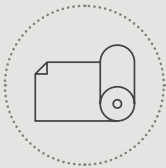
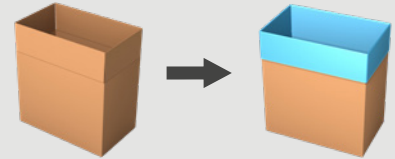

made-to-measure
bags from a reel

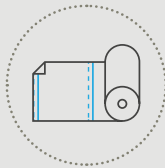

pre-made bags
from a reel

SOF
seal off first



Case lining convenience

- Continuous production thanks to the **automatic film roll exchange**.
- Super **compact**: only 67 x 47 inches floor space needed.
- **15" HMI** to facilitate operator convenience.

Your intelligent bag inserter

- **Up to 12 cases/minute**.
- Quick and **ergonomic film roll loading**.
- **Patented smart film opening technology**.



Watch our videos
at pattyn.com

TECHNICAL SPECIFICATIONS ZIM-31

Made-to-measure bags from a reel

- Continuous tubular gusseted film on a reel.
- Impulse sealing for a controlled and clean seal.

Pre-made bags from a reel

- Pre-sealed and perforated bags on a reel for optimal convenience.

Failsafe bag opening

- New strong gripper and spoon module.
- Patented smart film opening technology with a special vacuum and air insertion system.

Perfectly controlled bag insertion

- Case flap holders for perfect case flap positioning.
- Servo driven up and down movement of the gripper frame for a steady and smooth operation.

Operator friendly design

- Good maintenance accessibility.
- Improved interface with 15" HMI to facilitate operator convenience.

Standard equipped with:

- 15" HMI
- remote access point (one per line).
- Infeed conveyor with separator.

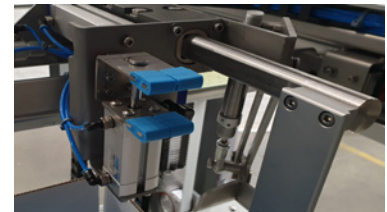

Mechanical grippers & spoons

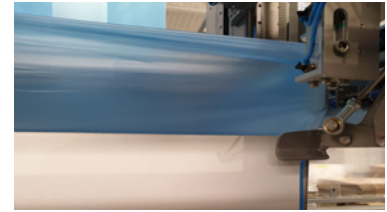

Case flap holders



Automatic film roll exchange (optional)

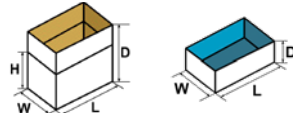

15" HMI

CONTAINER SPECIFICATIONS (For other dimensions, please contact Pattyn)	
Type	Boxes, trays and crates
Range (L x W // D) inches	Mono or multi footprint (L x W) /variable heights Min. 12" (L) x 8" (W) // 10" (D) Max. 24" (L) x 16" (W) // 26" (D)
	Outside dimensions
FILM SPECIFICATIONS	
Type	Tubular film with gussets
Thickness	As from 0,6 mil
Weight of film roll	Max. 26 lbs
Outside diameter film roll	Max. 9"
Inside diameter of core	3"
OUTPUT AND CONSUMPTION	
Output	Up to 12 c/min (Depending on case sizes)
Installed power	4,5 kW
Voltage	3 x 480 V + E / 60 Hz
Air supply	90 PSI, (1/2" min)
Air consumption	2 ft ³ / cycle
Weight	1433 lbs
OPTIONS (More options are available, please contact Pattyn)	
Automatic film roll exchange	Advanced stainless steel execution
Thermo transfer printer	Air plunger for improved bag positioning
Automatic format change	
MAX footprint (31 ^{1/2} " x 23 ^{5/8} "	

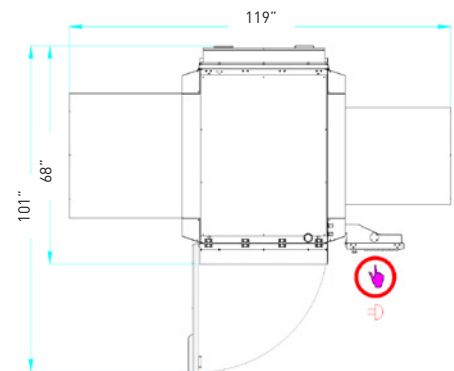

Machine height with film roll door closed: 82"
Machine height with film roll door open: 89"

Pattyn North America Inc.
N56 W24660 N Corporate Circle
Sussex, WI. 53089 - U.S.A

Ph +1 262-966-0300
Fax +1 262-966-0312
SalesUsa@pattyn.com



The description, pictures and information given have an indicative value. We reserve the right to make changes without notice. Information and content is property of Pattyn. For customized executions please contact Pattyn. ZIM-31 2021 - V01

PATTYN[®]

Turnkey solutions for industrial packaging.