

BAG INSERTER ZIM-31

From a roll of polyethylene film, the compact ZIM-31 automatically inserts bags into boxes, crates or trays.

The bag inserter runs with **made-to-measure bags** or **pre-made bags from a 12 kg reel** and handles multi box footprints.

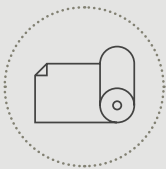
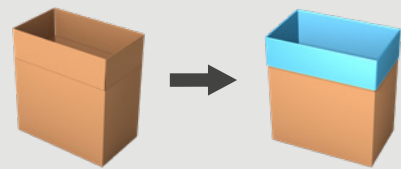

made-to-measure
bags from a reel

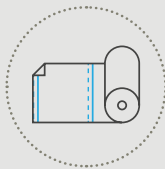

pre-made bags
from a reel

SOF
seal off first



Case lining convenience

- Continuous production thanks to the **automatic film roll exchange**.
- Super **compact**: only 1,7 x 1,3 m floor space needed.
- **15" HMI** to facilitate operator convenience.

Your intelligent bag inserter

- **Up to 12 cases/minute**.
- Quick and **ergonomic film roll loading**.
- **Patented smart film opening technology**.

Made-to-measure bags from a reel

- Continuous tubular gusseted film on a reel.
- Impulse sealing for a controlled and clean seal.

Pre-made bags from a reel

- Pre-sealed and perforated bags on a reel for optimal convenience.

Failsafe bag opening

- New strong gripper and spoon module.
- Patented smart film opening technology with a special vacuum and air insertion system.

Perfectly controlled bag insertion

- Case flap holders for perfect case flap positioning.
- Servo driven up and down movement of the gripper frame for a steady and smooth operation.

Operator friendly design

- Good maintenance accessibility.
- Improved interface with 15" HMI to facilitate operator convenience.

Standard equipped with:

- 15" HMI.
- Remote Access Point (one per line).
- Infeed conveyor with separator.

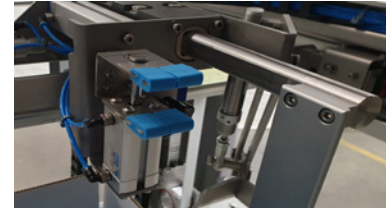

Mechanical grippers & spoons

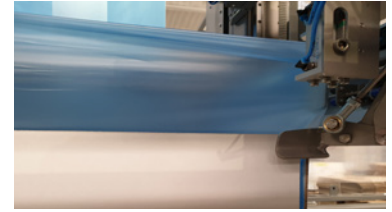

Case flap holders

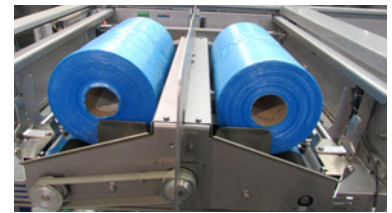

Automatic film roll exchange (optional)

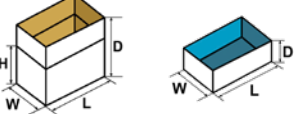

15" HMI

CONTAINER SPECIFICATIONS (For other dimensions, please contact Pattyn)	
Type	Boxes, trays and crates
Range (L x W // D) mm	Multi footprint (L x W) /variable heights Min. 300 (L) x 200 (W) // 250 (D) Max. 610 (L) x 410 (W) // 650 (D)
	Outside dimensions
FILM SPECIFICATIONS	
Type	Tubular film with gussets
Thickness	As from 15 µm
Weight of film roll	Max. 12 kg
Outside diameter film roll	Max. 230 mm
Inside diameter of core	76 mm
OUTPUT AND CONSUMPTION	
Output	Up to 12 c/min (Depending on case sizes)
Installed power	4,5 kW
Voltage	3 x 400 V + N + E / 50 Hz
Air supply	6 bar / 1/2" min
Air consumption	45 NL / cycle
Weight	650 kg
OPTIONS (More options are available, please contact Pattyn)	
Automatic film roll exchange	Advanced stainless steel execution
Thermo transfer printer	Air plunger for improved bag positioning
Automatic format change	

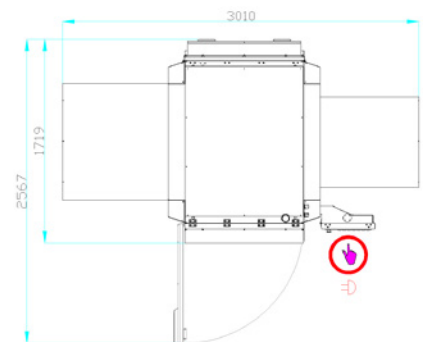

Machine height with film roll door closed: 2095 mm
Machine height with film roll door open: 2255 mm

Pattyn Packing Lines nv
Industriepark 'Blauwe Toren'
Hoge Hul 2, 8000 Brugge - Belgium

T +32 (0) 50 450 480
info@pattyn.com
www.pattyn.com



The description, pictures and information given have an indicative value. We reserve the right to make changes without notice. Information and content is property of Pattyn. For customised executions please contact Pattyn. ZIM-31 2021 - V01

PATTYN[®]

Turnkey solutions for industrial packaging.